

Series 88 & 89

Pressure Safety Valves
ASME Section VIII - NB Certified
for Air, Gas and Steam applications.



APPLICATIONS INCLUDE:

For steam, air or gas protection. Designed for durability, yet an economical choice for safety and relief applications. UV stamped; factory set and sealed. Choose for a variety of applications.

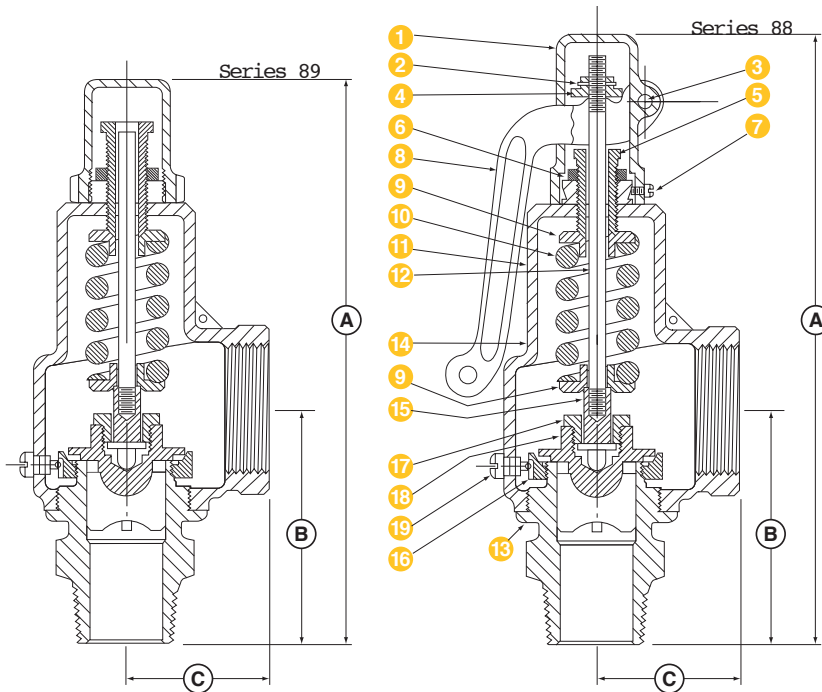

PARTS IDENTIFICATION & MATERIALS		
ITEM	PART NAME	MATERIAL
1	HOOD	BRONZE
2	COTTER PIN	STEEL *
3	LIFT LEVER PIN	BRASS
4	LIFTER NUT	BRASS/STEEL *
5	PRESSURE SCREW	BRASS
6	LOCK NUT	BRASS
7	HOOD SCREW	BRASS
8	LIFT LEVER	BRONZE
9	SPRING PLATE	BRASS/STEEL *
10	SPRING	STAINLESS STEEL
11	NAME PLATE	BRASS/BRONZE
12	SPRING POST	BRASS/STEEL
13	BODY	BRASS
14	BONNET	BRASS/BRONZE
15	SPRING PLATE SUPPORT	BRASS
16	REGULATOR RING	BRASS
17	SPRING PLATE	BRASS
18	DISK	BRASS/BRONZE
19	REGULAR SCREW	BRASS

*STEEL PLATED

SIZES FROM 1/2" TO 3"
PRESSURE TO 250 PSIG
TEMPERATURES TO 406° F



SERIES 88 & 89 DIMENSIONS • AIR/GAS/STEAM				PLEASE SPECIFY SERIES, SIZE, SERVICE AND SET PRESSURE.						
SERIES	VALVE SIZE	OUTLET SIZE	SEAT SIZE	SERIES 88 A	SERIES 89 A	B	C	MAX. SET PRESSURE PSIG	WEIGHT (Lbs.) SERIES 88	WEIGHT (Lbs.) SERIES 89
88-A1	1/2"	1/2"	A-1/2"	6 1/2	5 7/8	2 1/8	1 3/8	300	2	1.5
88-A2	1/2"	3/4"	A-1/2"	6 1/2	5 7/8	2 1/8	1 3/8	300	2	1.5
88-B1	3/4"	3/4"	B-3/4"	6 7/8	6	2 3/8	1 3/8	300	2.5	2
88-B2	3/4"	1"	B-3/4"	6 7/8	5	2 3/8	1 3/8	300	2.5	2
88-C1	1"	1"	C-1"	7 1/2	7 1/2	2 3/4	1 7/8	300	3.375	3
88-C2	1"	1 1/4"	C-1"	7 1/2	7 1/2	2 3/4	1 7/8	300	3.375	3
88-D1	1 1/4"	1-1/4"	D-1 1/4"	8 1/2	8 1/2	3 1/4	2	300	4.625	4.5
88-D2	1 1/4"	1 1/2"	D-1 1/4"	8 1/2	8 1/2	3 1/4	2	300	4.625	4.5
88-E1	1 1/2"	1-1/2"	E-1 1/2"	9 3/4	9 3/4	3 1/2	2 1/2	300	7	6.5
88-E2	1 1/2"	2"	E-1 1/2"	9 3/4	9 3/4	3 1/2	2 1/2	300	7	6.5
88-F1	2"	2"	F-2"	11 1/8	11 1/8	4	2.625	300	10.125	9.25
88-F2	2"	2 1/2"	F-2"	11 1/8	11 1/8	4	2.625	300	10.125	9.25
88-G1	2 1/2"	2 1/2"	G-2 1/2"	13 1/4	12	4 3/4	3 1/8	300	22.25	21
88-G2	*2 1/2"	3"	G-2 1/2"	13 1/4	12	4 3/4	3 1/8	300	22.25	21
88-H1	*3"	3"	H-3"	15	13 1/2	5 1/8	4 3/8	300	23	22

STANDARD VALVE FOR AIR, GAS AND STEAM IS "NEXT SIZED OUTLET" (UNLESS OTHERWISE SPECIFIED)

BAR = PSIG x .06895 Centimeters = Inches x 2.540 KG = LBS x .4536

*2 1/2" & 3" ORIFICE AND PRESSURES OVER 250 PSI-NOT ASME/NB.



SERIES 88



Steam Capacity in Pounds Per Hour (Lbs/Hr)

SERIES 88 CAPACITIES • STEAM ASME Code Section VIII (UV)-National Board Certified • Sizes: 1/2" - 3"

SET PRESSURE PSIG	A 1/2"	B 3/4"	C 1"	D 1 1/4"	E 1 1/2"	F 2"	G* 2 1/2"	H* 3"
5	37	53	129	199	279	420	763	960
10	47	67	164	253	355	535	968	1221
15	56	81	199	307	431	649	1173	1483
20	66	96	235	361	507	763	1383	1745
25	76	110	270	415	852	878	1590	2006
30	86	124	305	469	658	992	1797	2267
35	96	139	240	523	734	1107	2004	2529
40	106	153	375	278	810	1221	2212	2790
45	116	168	410	632	886	1335	2418	3052
50	126	182	445	686	962	1450	2626	3313
55	136	196	480	470	1038	1564	2833	3575
60	146	211	516	794	1114	1679	3040	3836
65	156	225	551	848	1190	1793	3247	4098
70	166	239	586	902	1265	1907	3454	4359
75	176	254	621	956	1341	2022	3662	4620
80	186	268	656	1011	1417	2136	3869	4882
85	196	282	691	1065	1493	2251	4076	5143
90	206	297	726	1119	1569	2365	4283	5405
95	216	311	762	1173	1645	2479	4490	5667
100	226	325	797	1227	1721	2594	4698	5928
110	246	354	867	1335	1873	2823	5113	6451
120	266	383	937	1443	2024	3051	5526	6974
130	285	412	1007	1552	2176	3280	5940	7497
140	305	440	1078	1660	2328	3509	6355	8020
150	325	469	1148	1768	2480	3438	6771	8542
160	345	498	1219	1876	2632	3967	7184	9066
170	365	526	1289	1985	2783	4195	7598	9589
180	385	555	1359	2093	2935	4424	8012	10111
190	405	584	1429	2201	3087	4653	8427	10635
200	425	613	1500	52309	3239	4882	8843	11157
210	445	641	1570	2418	3391	5111	9256	11680
220	465	670	1640	2526	3542	5339	9670	12204
230	485	699	1711	2634	3694	5568	10084	12726
240	505	727	1781	2742	3846	5797	10499	13249
250	525	756	1851	2841	3998	6026	10915	13772
260*	545	785	1921	2949	4150	6255	11330	14295
270*	565	814	1991	3057	4302	6484	11745	14818
280*	585	843	2061	3165	4454	6713	12160	15341
290*	605	872	2131	3273	4606	6942	12575	15864
300*	625	901	2201	3381	4758	7171	12990	16387

BAR = PSI x .06895 Kilograms = PPH x .4536 *2 1/2" & 3" AND PRESSURES OVER 250 PSI - NOT ASME/NB





Capacity in Standard Cu. Ft. Per Minute (SCFM) ASME

SERIES 88 & 89 CAPACITIES • AIR/GAS AIR/GAS ASME Code Section VIII (UV)-National Board Certified • Sizes: 1/2" - 3"

SET PRESSURE PSIG	A 1/2"	B 3/4"	C 1"	D 1 1/4"	E 1 1/2"	F 2"	G* 2 1/2"	H* 3"
5	13	18	46	71	99	150	281	343
10	17	24	58	90	126	190	348	441
15	20	29	71	109	153	231	418	530
20	24	34	83	129	180	272	492	623
25	27	39	96	148	207	312	565	717
30	31	44	108	167	234	353	639	810
35	34	49	121	186	261	394	714	903
40	38	55	133	206	288	435	787	997
45	41	60	146	225	315	475	861	1090
50	45	65	158	244	341	516	934	1184
55	48	70	171	264	368	557	1009	1277
60	52	75	183	283	395	598	1082	1370
65	55	80	196	302	422	638	1156	1464
70	59	85	208	321	449	679	1230	1557
75	63	90	221	341	476	720	1302	1650
80	66	95	234	360	503	760	1378	1744
85	70	101	246	379	530	801	1452	1837
90	73	106	259	398	557	842	1525	1934
95	77	111	271	418	584	883	1599	2024
100	80	116	284	437	611	923	1671	2117
110	87	126	309	475	665	1005	1818	2304
120	94	136	334	514	719	1086	1968	2491
130	102	147	359	553	773	1168	2116	2678
140	112	162	396	610	754	1290	2337	2958
150	116	167	409	630	880	1330	2408	3051
160	123	177	434	668	934	1412	2558	3238
170	130	188	459	707	988	1493	2706	3425
180	137	198	484	745	1042	1575	2854	3612
190	144	208	509	784	1096	1656	3001	3798
200	151	218	534	822	1150	1738	3145	3985
210	158	228	559	861	1204	1819	3296	4172
220	165	239	584	899	1258	1900	3444	4359
230	172	249	609	938	1312	1982	3591	4545
240	179	259	634	977	1366	2063	3739	4732
250	187	269	659	1015	1420	2145	3882	4919
260*	194	279	684	1053	1474	2227	4025	5106
270*	201	289	709	1091	1528	2309	4168	5293
280*	208	299	734	1129	1582	2391	4311	5480
290*	215	309	759	1167	1636	2473	4454	5667
300*	222	319	784	1205	1690	2555	4597	5854

BAR = PSI x .06895. SM³/MIN = SCFM x 0.028

*2 1/2" & 3" AND PRESSURES OVER 250 PSI - NOT ASME/NB



A brass safety valve with a lifting lever on top and a threaded outlet on the side. The valve is shown against a grey background.

**SERIES
88**

Usages :

- Over-pressure protection
- Pressure vessels
- Piping systems
- Safety relief
- Compressors and dryers
- Vacuum relief
- Pressure reducing stations
- Intercoolers and aftercoolers
- Pressured piping lines and tanks

Features :

- Adjustable tuned blow-down
- Precision lapped metal-to-metal seating.
- Stainless steel springs
- Ruggedly constructed
- Closed seal hex cap or lever* option
- Wide variety of inlet and outlet options
- Disk-guided seat provides quick, accurate and excellent re-seating

Options:

- Chrome plating
- Oxygen cleaning
- Female inlet
- BSPT connections

A brass safety valve with a hex cap on top and a threaded outlet on the side. The valve is shown against a grey background.

**SERIES
89**

*LIFTING LEVER IS REQUIRED BY ASME FOR STEAM SERVICES.
2-1/2" AND 3" ARE NOT NB CERTIFIED.
PLEASE SEE CAPACITY AND SIZE CHARTS.



10195 Brecksville Road, Brecksville, OH 44141 USA • Telephone: +1.440.838.7690 • Fax: +1.440.838.7699 • E-mail: farris@curtisswright.com
Facilities: Brecksville, OH USA, Brantford, Ontario, Edmonton, Alberta, Canada, Kettering, Northants, UK, Delhi, India
Offices: worldwide. For a listing of our global sales network, visit our website at www.farrisengineering.com

While this information is presented in good faith and believed to be accurate, Curtiss-Wright Flow Control Corporation, Farris Engineering, does not guarantee satisfactory results from reliance on such information. Nothing contained herein is to be construed as a warranty or guarantee, expressed or implied, regarding the performance, merchantability, fitness or any other matter with respect to the products, nor as a recommendation to use any product or process in conflict with any patent. Curtiss-Wright Flow Control Corporation, Farris Engineering, reserves the right, without notice, to alter or improve the designs or specifications of the products described herein. Valves are manufactured, assembled, set and tested by Aquatrol, Inc.